

Article number: 3918044010223

Description: Worm gear with st. steel hollow shaft
VF 44 EP-A-10- 63B14

Measures

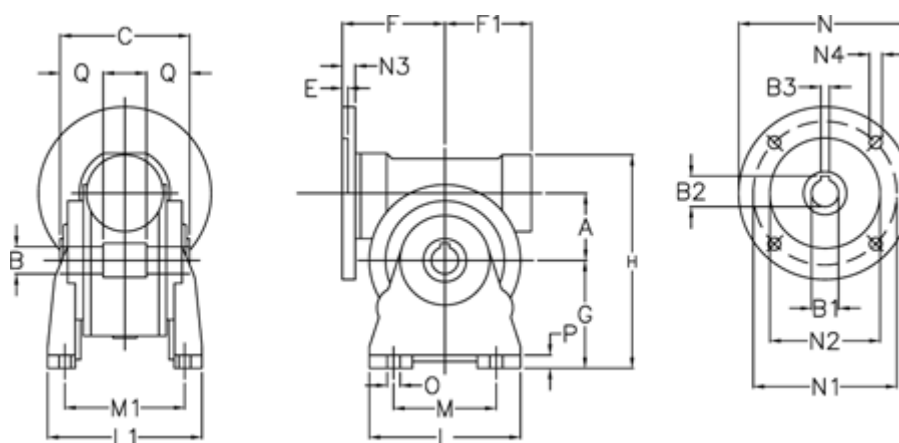

a = 44.6	F1 = 54	N1 = 75
B = 18	g = 72	N2 = 60
B1 E7 = 11	H = 143	N3 = 8.0
B2 = 12.8	L = 90	N4 = 5.5
B3 H9 = 4	L1 = 98.0	O = 8.5
C = 64	m = 52	P = 10
E = 2.0	M1 = 81.0	Q = 24.5
F = 65	N = 90	